

Replacement

1. Disconnect the negative (-) battery terminal.
2. Remove the console under cover (B).

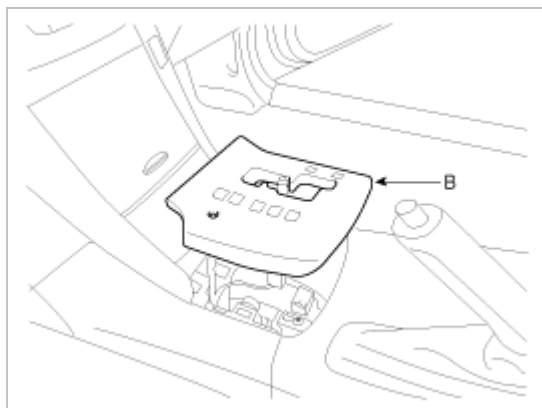

3. Remove the side garnish(A). (Refer to the Body group - crash pad)

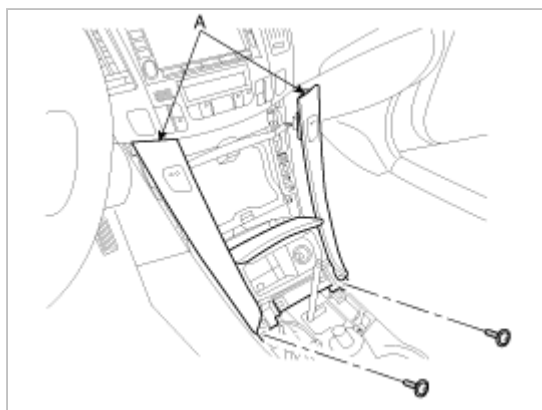

4. Remove the center garnish(A).

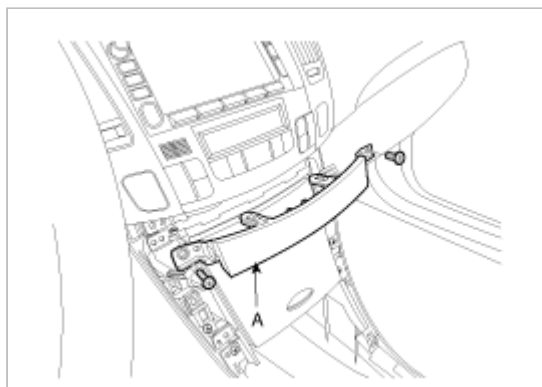

5. Remove the crash pad center facia panel(A).

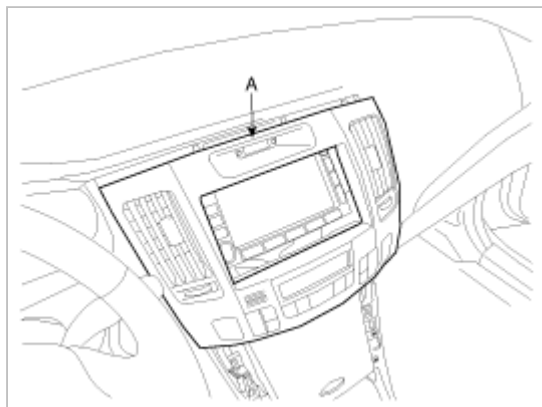

6. Remove the clock connector(A) and heater control unit connector(B).

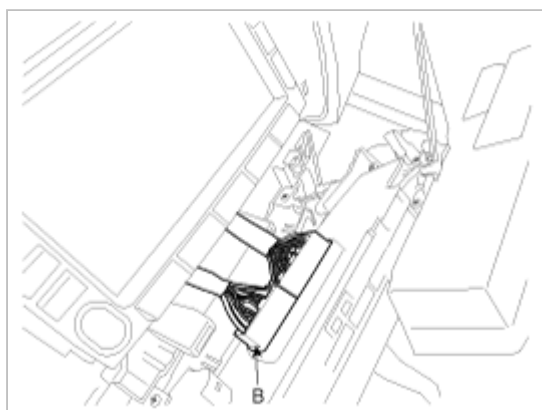
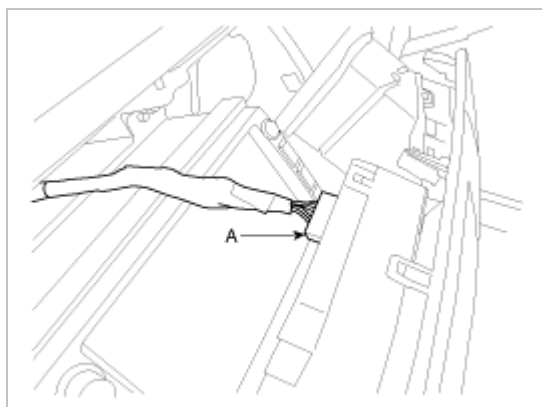

7. Remove the mounting screws then remove the audio unit (A).

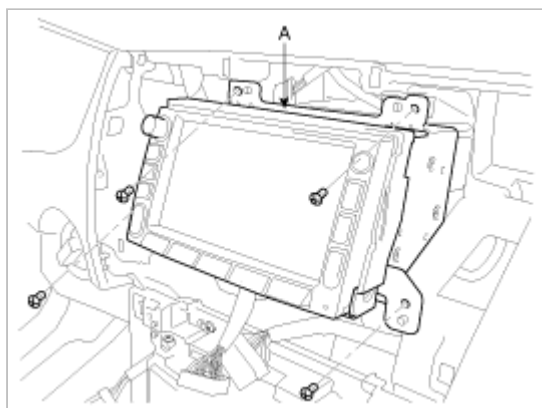

8. Remove the the audio unit connectors and cables(A).

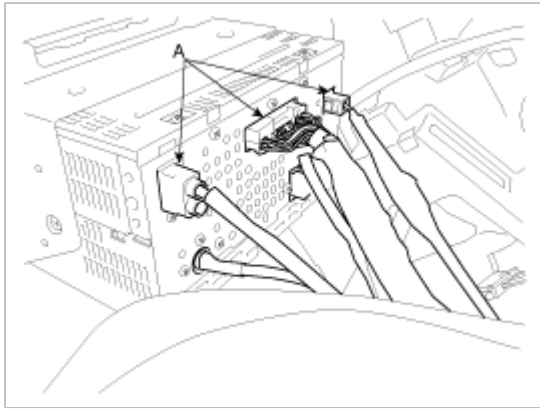

9. Installation is the reverse of removal.